

The iconic **F82 bifold door**



Innovation, not imitation

The Luminia F82 bi-fold door has been designed with style and performance front of mind. It cleverly combines the intimacy of inside spaces with the freedom of outside living, without ever compromising on performance, safety or security.

And like all AluK aluminium façade systems, it continues to push the industry forward by delivering unrivalled innovation and installation simplicity.

For starters, it delivers an industry-best 1.3 U-value thermal performance for double glazed units and 0.9 U-value for triple glazed.

It boasts contemporary flush hardware, while the elegant slimmer symmetrical sightlines of the frame and panels provide larger glazing area than others on the market, flooding the home with more natural light.

As ever, we believe the highest levels of safety and security should be as standard, not an aspiration. It is why the F82 conforms to the latest British Standards and Building Regulations.

AT A GLANCE:

- › **Exceptional wind and water performance** – highest possible water resistance test results
- › **Floating corner creates a seamless transition between inside and outside** – uninterrupted view.
- › **Unique flush pop-up handle** – fully cycle tested for around 80 years reliable use
- › **Integrated clip-in cills** – reduce the sightlines further

Typically **unique**

As the experts for designing and engineering aluminium window, door and bi-fold systems, we're renowned for delivering industry firsts. That's why we've pushed ourselves to ensure the Luminia F82 equally leads the way.

Designed and engineered to withstand all the British weather can throw at it, the Luminia F82 delivers exceptional performance for air, wind and water resistance, evidenced by the market-leading test results. Our Patent-Applied design ensures durability throughout its life.

It has unrivalled thermal performance of 1.3 W/m²K with a double glazed unit and 0.9 W/m²K with a triple-glazed unit, which helps to lower CO₂ emissions and reduce heating bills by retaining the warmth in the home.

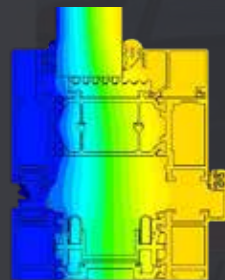

LUMINIA F82 ISOTHERM

The innovative thermal design includes an improved in-line and uniformed thermal break.

Heat transfer is optimised throughout the centre of the system resulting in market-leading U-value performance.





Smooth **operator**

Everything about the Luminia F82 has been developed with homeowner demands and ease of use in mind. The system is designed with heavy-duty slim stainless-steel rollers as standard and also boasts a unique gearbox for reliable operation.

The HD rollers can carry weights of up to 150kg, allowing larger sash sizes up to 1200mm wide by 3000mm high for a truly light-filled space.

The unique flush pop-out T-handle provides ease of operation, removing the need for additional unsightly handles and maintaining the minimal, flush aesthetic. The handle has been rigorously cycle tested at 25,000 operations, which equates to approximately 80 years of reliable use.

Now, as well as selecting your handles in black, white, silver and grey, you can complement your room design with our new brushed stainless-steel pop-up handle and traffic door handle.



THE TOUGHEST HARDWARE

Hardware fitted to the doors has been corrosion tested to 480hrs (Grade 5 - EN1670:2007)

Room with a **view**

Outside space has never been more important and appreciated, and installing bifold doors gives you the opportunity to enjoy your view and create a seamless link between your home and garden. With greater glazing areas and the desirable slimmer sightlines that the F82 is renowned for, you can flood your rooms with more natural light.

The introduction of a new floating corner takes that ability to bring the outside in a step further, offering you uninterrupted views of your garden space with the same smooth operation, total security and unrivalled weather performance that you'd expect from the unique F82.

BRING THE OUTSIDE IN

Open up inside spaces with a floating corner



Safe and **secure**

To ensure total peace of mind, the F82 has been put through its paces to ensure it conforms to all the latest British Standard and Building Regulations for thermal, security and safety, including PAS24**

For added security, the Luminia F82 features a 5-point multi-locking mechanism with top and bottom bolts on the traffic door.

And for extra safety, magnetic catches that hold the doors in place whilst being operated. As well as an anti-crush system, using gaskets, to prevent fingers getting injured when the doors are closing.



**Only minimal hardware changes needed in order to turn standard door set ups into PAS 24 Enhanced Security compliant.



Intelligently **simple**

We have a passion for innovation at AluK. The Luminia F82 bi-fold continues the trend. Larger glazing panels, faster fabrication and installation thanks to fewer parts and profiles, while panel size options of up to 3000mm high* provide complete project flexibility.

To speed up fabrication, we've reduced the number of parts and profiles without compromising on the ease of installation. For simplicity, you can fabricate the F82 with just four profiles, helping reduce your stock holding.

Exceptional performance

The F82 has been engineered to deliver outstanding performance thanks to its innovative features:

- ▶ Unique pop-up handle, cycle tested to 25K operations which equates to around 80 years of reliable use
- ▶ HD bottom rollers for smoother operation
- ▶ The jamb and interlock seal provides enhanced wind and water tightness, offering extra protection against extreme weather conditions

Design Flexibility:

- ▶ Floating corner – achieve a truly seamless outside/inside design with this exciting new option to the F82 range.
- ▶ Integrated cills – developed with a new outer frame profile. Reduce the sightlines further by clipping the cills onto either side of the outer frame, rather than sitting on top of the frame with the new integrated cill profile. This new outer frame and integrated cill option presents a cost saving of up to 45% on a standard 3metre bifold.
- ▶ Sub cill range – position the F82 onto varying widths of constructions using the 225mm, 150mm or 95mm options.
- ▶ 110mm mid rail – To compliment the existing 55mm mid rail – now as well as creating panels, you can insert a transom into the door or create solid panels in single and double doors for a uniform aesthetic.

The F82 still offers the same great features for fabricators

- ▶ HD rollers with a 150kg capacity – allowing you to make 3600mm wide bifold doors in 3 panes.
- ▶ Ability to make single and double doors in the same material, retaining PAS 24 certification.

*Available on special applications



Clear choice

We understand every project is different, which is why the Luminia F82 is available with panels up to 3000mm* and weights of 150Kg. We also offer glazing add-ons and the option for both internal and external glazing.

PERFORMANCE AND ACCREDITATION	OPEN-IN	OPEN-OUT
⁰ U-value (double glazing) (Ug: 1.0 W/m²K)	1.3 W/m²K	1.3 W/m²K
¹ U-value (triple glazing) (Ug: 0.5 W/m²K)	0.9 W/m²K	0.9 W/m²K
Air tightness (Pa) (standard threshold)	Class 3 (600 Pa)	Class 4 (600 Pa)
Water tightness (Pa) (standard threshold)	Class 5a (200 Pa)	Class E900 (900 Pa)
Wind load (Pa)	Class B3 (1200 Pa)	Class B3 (1200 Pa)
Security	PAS 24	PAS 24
DESIGN DETAILS		
Max vent weight	150Kg	
Sightline (Head)	97mm	
Sightline (Cill)	97mm	
Sightline (Jamb)	97mm	
Sightline (Interlock)	122mm	
Maximum leaf height	2500mm std > 3000*mm	
Maximum leaf width	1200mm	
SYSTEM FEATURES		
Frame depth	82mm	
Dual colour option	✓	
Multi-point locking	✓	
Glazing options	Internally beaded	
Glazing thickness	28mm – 44mm	

*The maximum height and panel width for the F82 Folding Sliding Door System are co-dependent and also dictated by the design wind load where the doors are being installed. Based on the site design wind load that the doors are subjected to this will influence the maximum height and width [per panel] to which the doors can be manufactured.

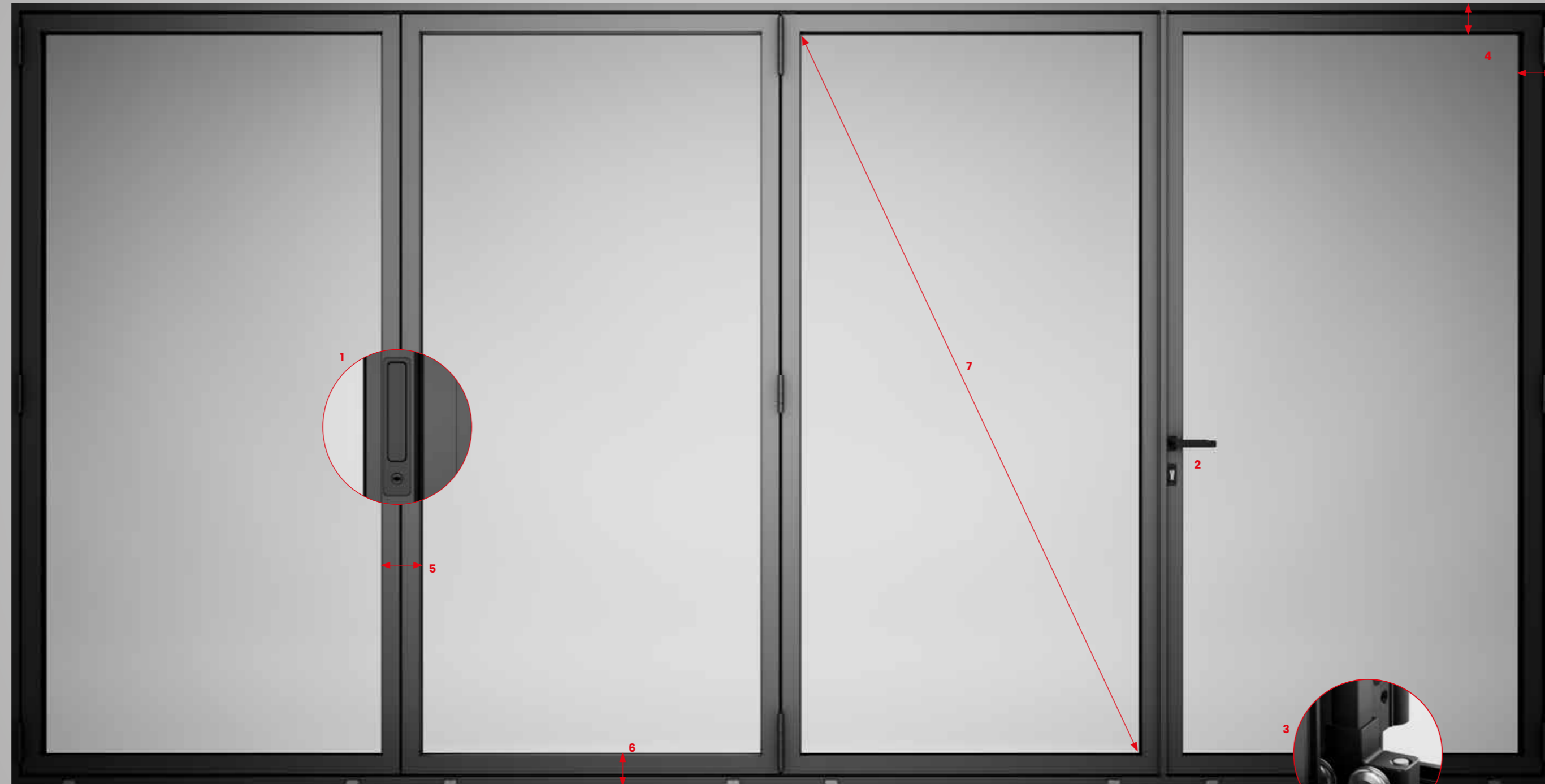

Visibly different

We understand the desire for slimmer sightlines, which is why the Luminia F82 has been designed with reduced outer frame rebates that are symmetrical. Combined with a 122mm interlock and a frame-to-glass sightline of 97mm, the F82 boasts greater glazing areas flooding the room with more natural light than ever before.

And, with the impressive floating corner option you can seamlessly connect the home and garden for greater open space living.

DESIGN FEATURES

- 1 / Unique flush pop-out handle for ease of operation, fully cycle tested for 80 years reliable use
- 2 / Unique traffic door handle
- 3 / Heavy duty compact rollers as standard
- 4 / Symmetrical head, jamb and cill sight lines of 97mm
- 5 / 122mm Slimline interlock
- 6 / New integrated cills for reduced sightlines
- 7 / Larger glazing area

OPTIONS

- Square bead
- Glazing 28mm – 44mm
- Available in a range of opening configurations
- Available in a range of single or dual colour and anodised finishes
- All configurations available open in and open out

Beautifully organised

As with all AluK aluminium system, you'll find an extensive choice of configurations available to choose from. And as ever, all are available as open in and open out for added homeowner choice.

TYPICAL CONFIGURATIONS

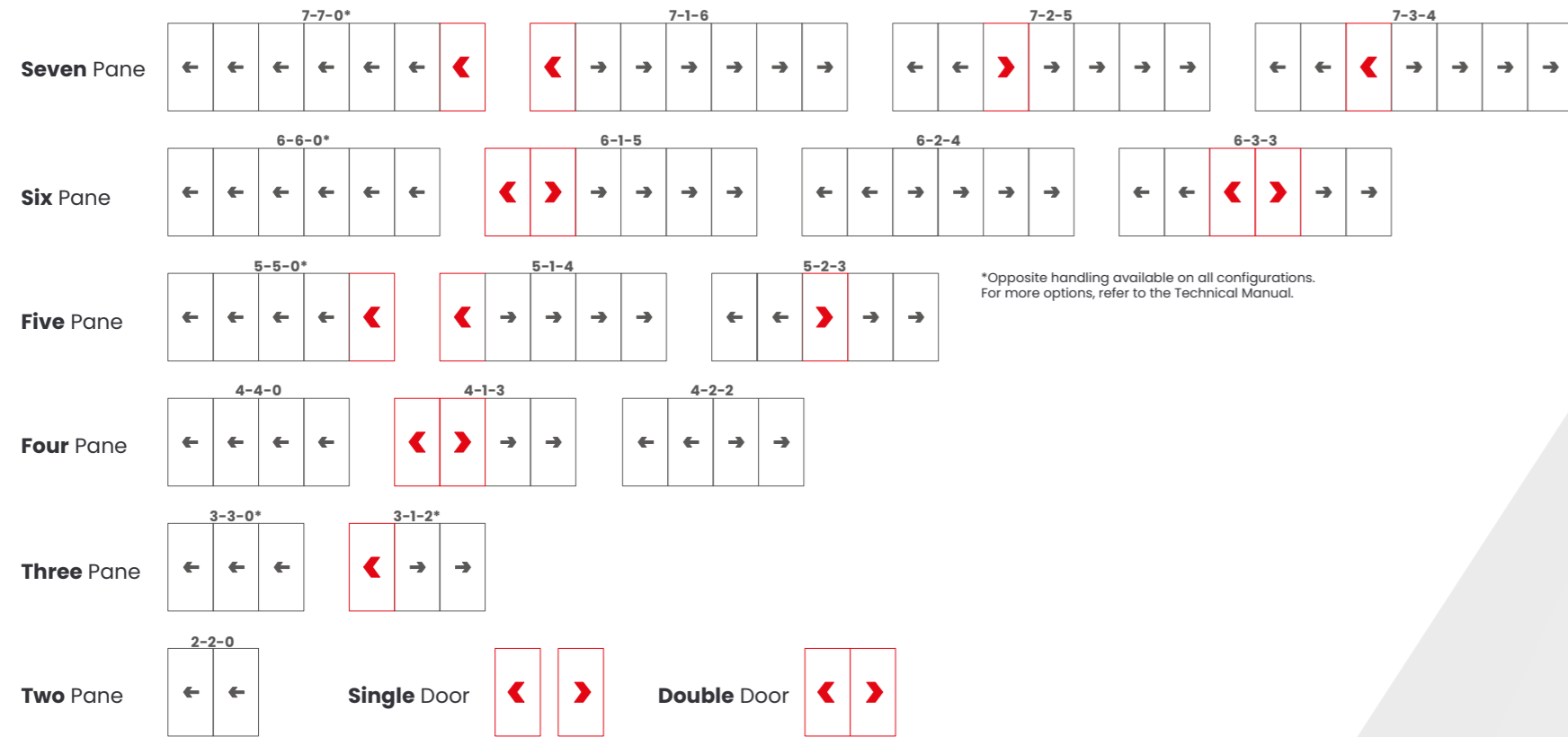

*Opposite handling available on all configurations. For more options, refer to the Technical Manual.



1 / SINGLE DOOR SIZE LIMITS (OPEN IN & OPEN OUT)

Leaf Dimension				Max Weight (Kg)
LB*		AB*		
Min	Max	Min	Max	
550	1200	1540	2600	150

2 / DOUBLE DOOR SIZE LIMITS (OPEN IN & OPEN OUT)

Leaf Dimension				Max Weight (Kg)
LB*		AB*		
Min	Max	Min	Max	
550	1200	1540	2500	150

3 / DOOR SIZE LIMITS - NO TRAFFIC DOOR (OPEN IN & OPEN OUT)

Leaf Dimension				Max Weight (Kg)
LB*		AB*		
Min	Max	Min	Max	
700	1200	1000	2600	150

4 / DOOR SIZE LIMITS (OPEN IN & OPEN OUT)

Leaf Dimension				Max Weight (Kg)
LB*		AB*		
Min	Max	Min	Max	
550	1200	1540	2500	150

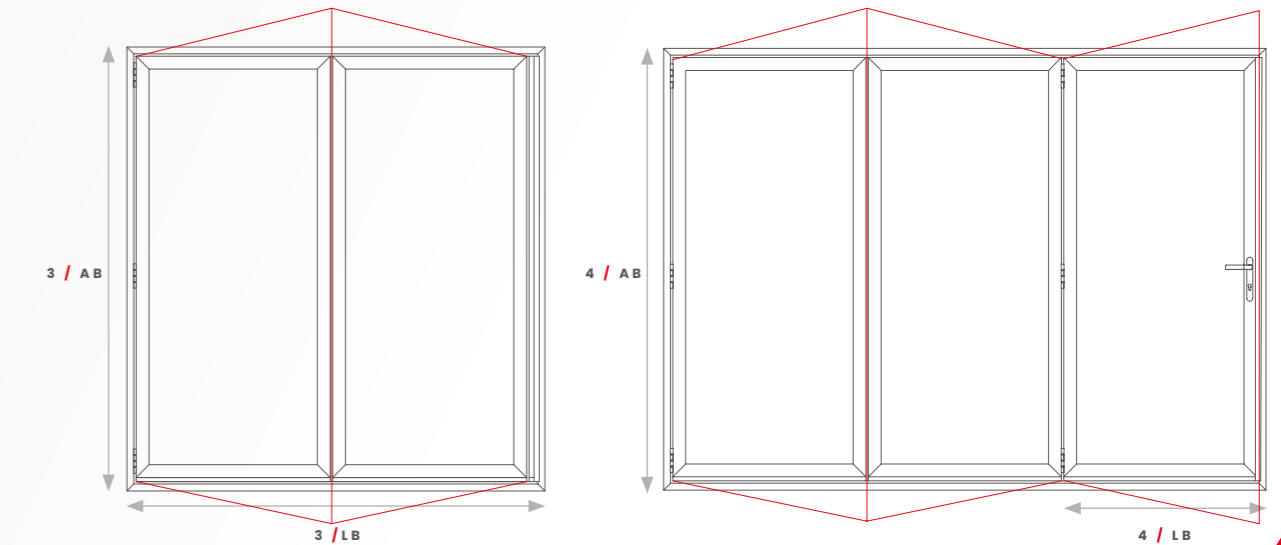
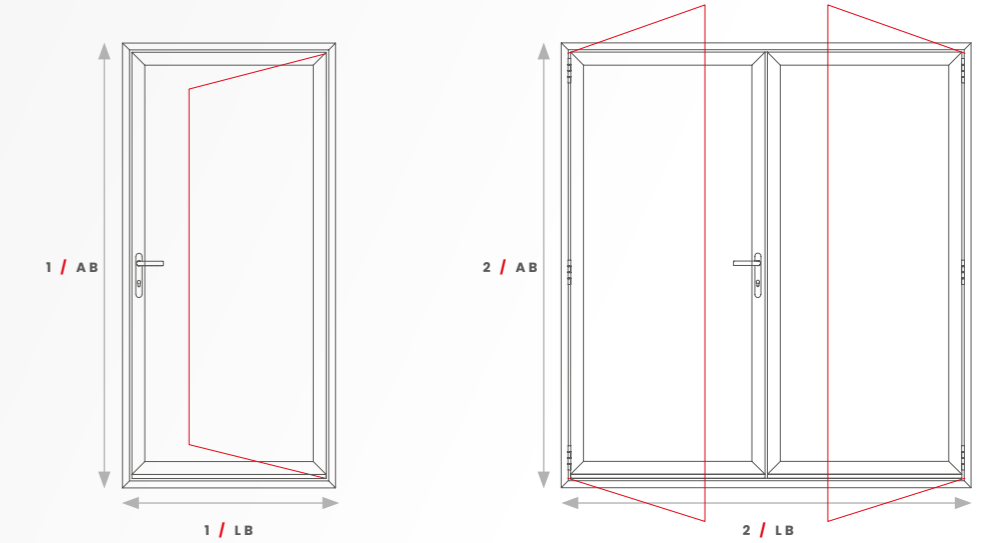



Colourful **choices**

If there's one thing architects, specifiers and homeowners all have in common, it's the desire for choice. That's why we offer an extensive range of colours and finishes to bring any project vibrantly alive.

It offers customers the freedom to let their imagination fly while providing installers with the quick turnaround and clear delivery schedules they demand.

So whether it's a standard single or dual colour, or one of the many vibrant RAL Colours available, the tone is set for service excellence.

STANDARD COLOURS

Hipca White 9910HG	Anthracite Grey 7016M
Chocolate Brown 8017M	Deep Black 9005M

STANDARD DUAL COLOURS

External Anthracite Grey 7016M	External Deep Black 9005M
Internal Hipca WhiteHG 9910HG	Internal Hipca WhiteHG 9910HG

POPULAR RAL COLOURS

1013M	1015M	7044M	9001M
7034M	1019M	6021M	7032M
3005M	9010M	6003M	7021M

CUSTOM RAL COLOURS AVAILABLE



Finishing touches

The Luminia F82 hardware is available in a range of colours designed with today's colour trends in mind. This includes our ergonomically designed traffic door handle, perfect for everyday use; and our flush pop-out T-handle, engineered for effortless operation when fully opening the door.

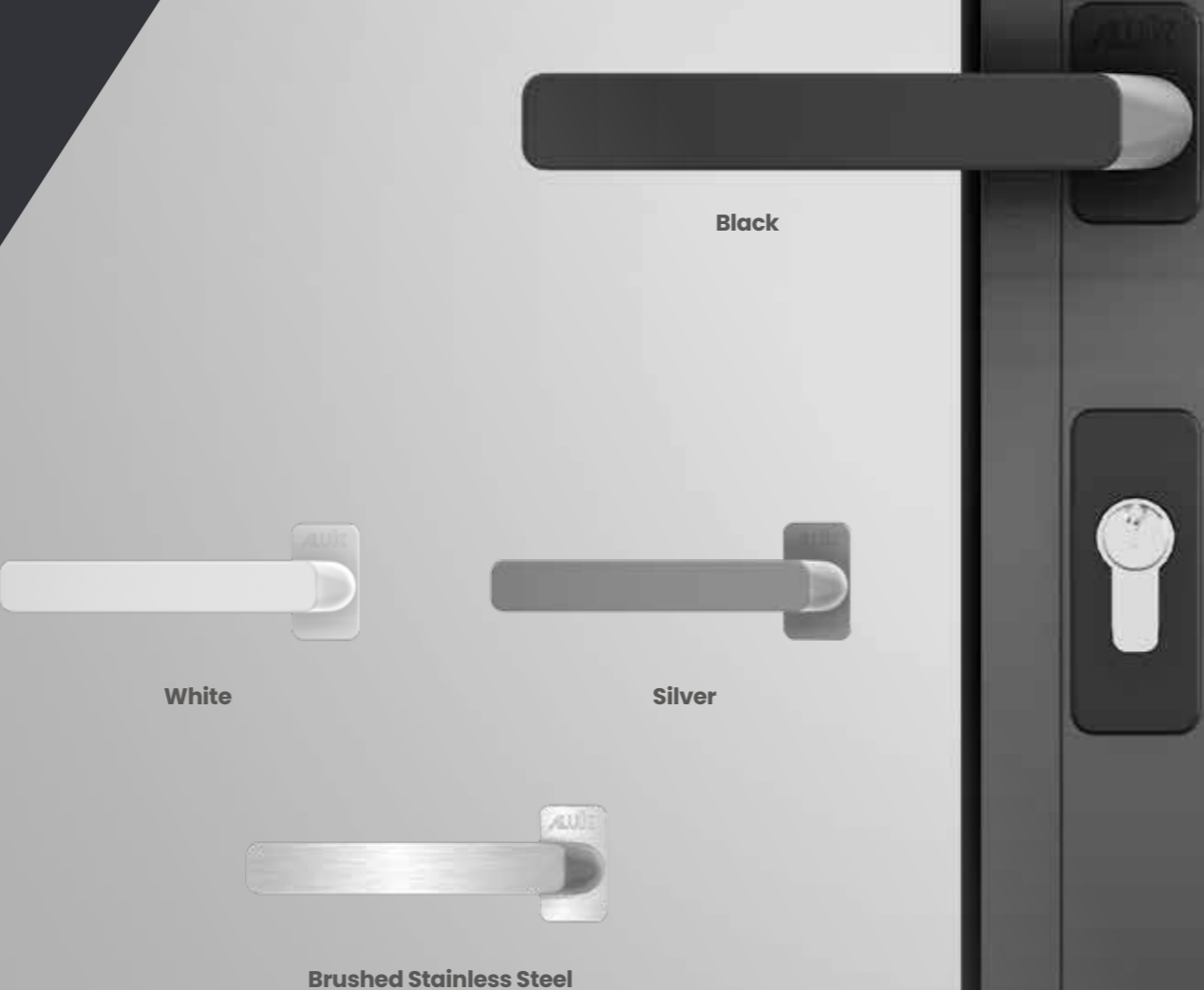

White



Silver



Brushed Stainless Steel



Black

CAD Cross Sections

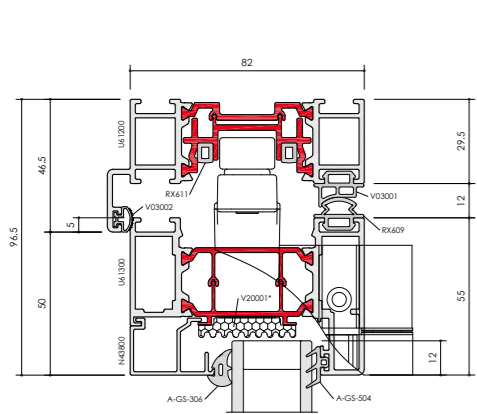

F82 HEAD / A

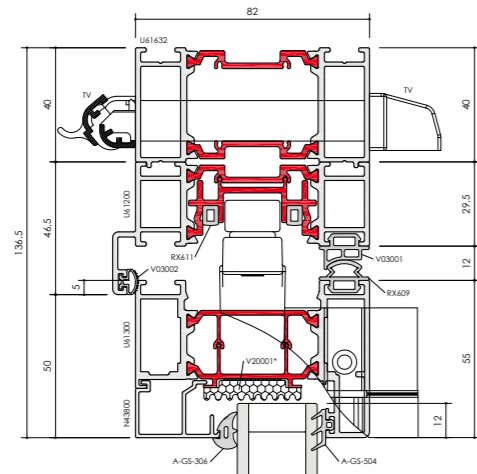

F82 HEAD WITH 40MM
ADDON FOR TRICKLE VENT / A1

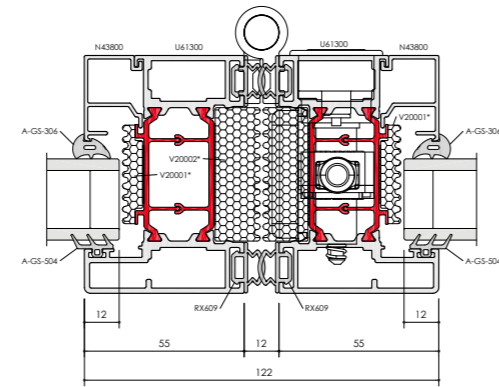

F82 MEETING STYLE / B

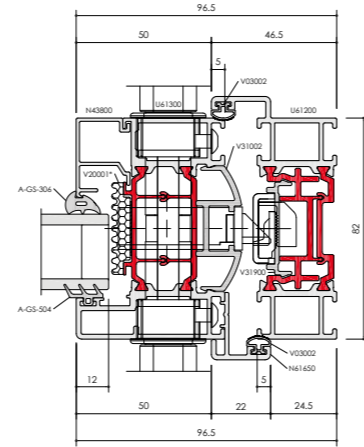

F82 LOCKING JAMB / C

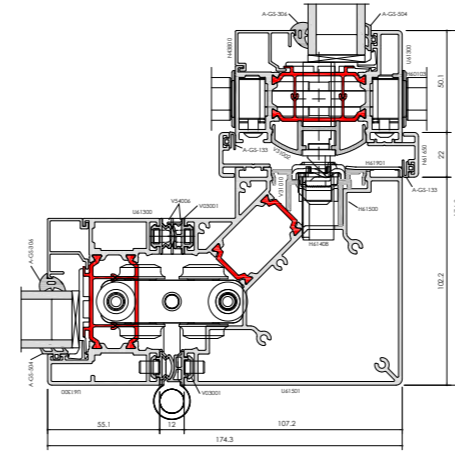

F82 FLOATING CORNER POST / C1

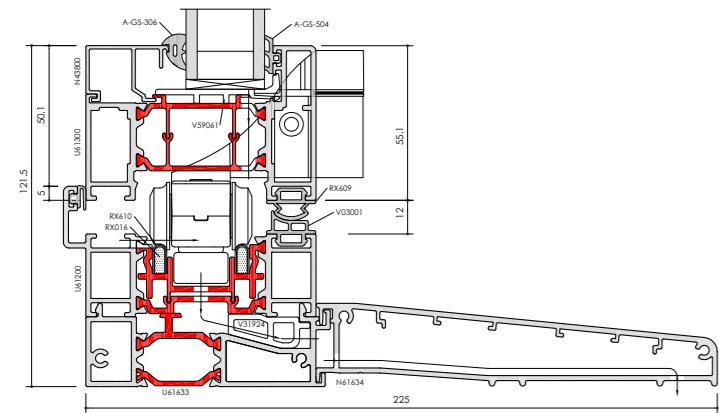

F82 CILL AND SUBCILL / D

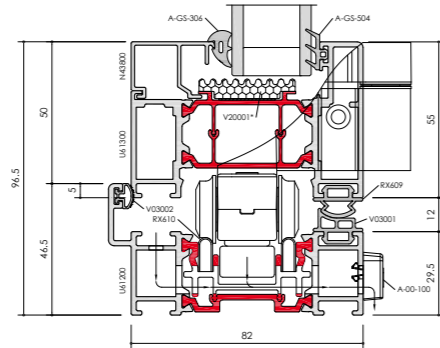

F82 WITH FACE DRAINAGE / D1

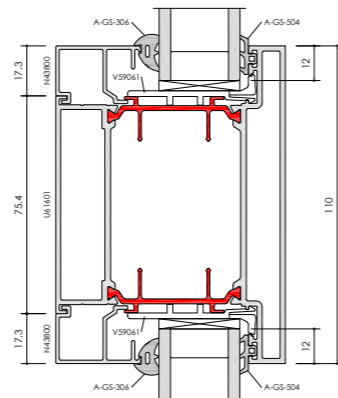

F82 MIDRAIL / E

CROSS SECTION ELEVATION

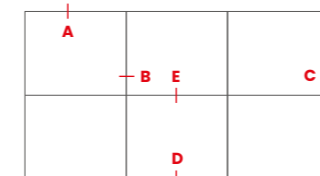



The right service – **customised, not compromised**

At AluK, we understand the challenges of modern building construction. For more than sixty years we have been working around the globe to deliver the finest tailored aluminium façade systems.

As part of AluK International, we have over 2,500 clients worldwide that have different challenges, which is why we offer different solutions wherever your project may be. We don't provide a one-size-fits-all service, we work with you, detailing the

specification your project really needs to make it the best it can be – whilst adopting a 'right first time and on-schedule' attitude.

You will also have the support of a dedicated project consultant team from design through to installation, who will advise on legislation and provide guidance throughout the RIBA Plan of Work.

Expertise, customised.



AluK GB at a glance



150+
employees



350,000 sq. ft
factory space with
500 sq. ft design studio,
based in Chepstow



4,000 sq. ft
architectural design
studio in central London



35,000
orders processed
per year



4,500 tonnes
aluminium sold per year
£190M installed value

The capability to deliver



Dedicated
project consultant team



Global leader
in powder coating technology,
including in-house pre-
anodisation



3,000,000 m
powder coating
completed per year

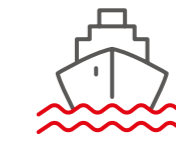

Marine Grade
paint as standard



3 thermal break
assembly lines



1,400 tonnes
of aluminium profile in stock,
held in the UK



End-to-end
supply of our systems
managed in-house

T: 01291 639 739
E: info.uk@aluk.com

Registered Office:
AluK (GB) Ltd
Newhouse Farm Ind Est
Chepstow
NP16 6UD

Registered Number:
02881320

aluk.co.uk

ALUK[®]