



**Guardian**  
Warm Roof  
Ireland



## Conservatory warm roof conversion system

**FULLY CERTIFIED**  
Conservatory Roof Replacement

Designed and Manufactured in Ireland



## IS YOUR EXISTING CONSERVATORY ROOF:

- Too hot in summer or too cold in winter?
- Waste of valuable living space?
- Unable to relax to watch TV?



# Transform your conservatory into a comfortable, all year round living space...



## ...WITH THE GUARDIAN WARM ROOF CONVERSION SYSTEM:

- High performance insulated warm roof conversion system
- Lightweight aluminium frame
- Provides energy cost savings
- Reduces rain noise and glare

The Guardian Warm Roof System is the biggest revelation to hit the home improvement market in the last ten years. You can now change your old conservatory roof for a new Guardian Roof and effectively turn your old conservatory into a new extension that can be used all year round. The complete changeover takes only three days with very minimal disruption to your household.

The Roof System is designed to replace the existing glass or polycarb roof of a conservatory while retaining the original windows, doors, frames and walls. At the same time providing substantial energy cost savings.

Fully tested and approved to all thermal and structural standards, the Guardian system is a high performance insulated roof system comprising of a pre-engineered lightweight frame, Aluthermo Quattro Insulation, internal insulated plasterboard, exterior grade plywood, vapour membrane and a choice of external tile finishes.



### Guardian warm roof construction

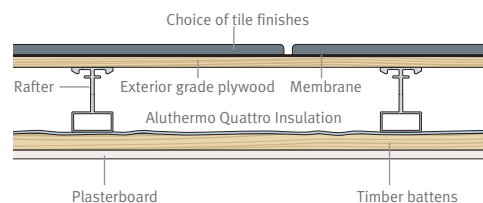







Guardian warm roof is a **complete** roof replacement, we do not leave any of the existing conservatory roof components in place as none of these profiles are designed to carry a solid roof structure.





## THE AFFORDABLE GUARDIAN WARM ROOF CONVERSION SYSTEM

-  Reduced fuel bills for the life of the roof
-  Comfortable ambient temperature all year round
-  A wide range of roof colours and finishes available
-  Achieves U Value of 0.16 (Ireland)

-  Thermal, structural and condensation risk tested
-  Fast installation utilising existing walls, windows and doors via our **nationwide installer network**
-  Fully guaranteed

# Roof design options

Guardian roof provide standard warm roof solutions for existing conservatory roof design. Bespoke solutions also available.

## Edwardian

The Classic Sunroom shape. Together with attractive roof windows the Edwardian Guardian Roof is the traditional safe bet for styling and convenience. The Edwardian shape also helps to maximise the room space below. The roof is very sympathetic to all house styles as its ridge is so versatile, it can also be be the perfect solution to a Bungalow extension.

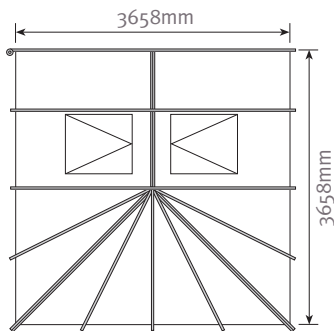
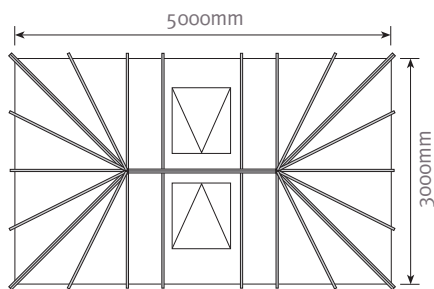

## Lean-to

The Guardian Lean-To is ideal to maximise space at the back of the house. The ends can either have one or two hips (slopes). It is ideal for kitchen extensions and can go as low as 15 Degrees with roof windows.

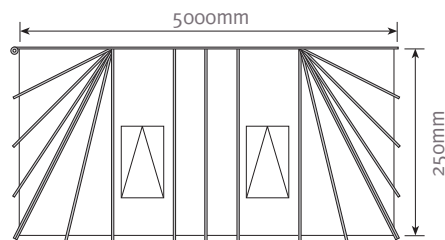
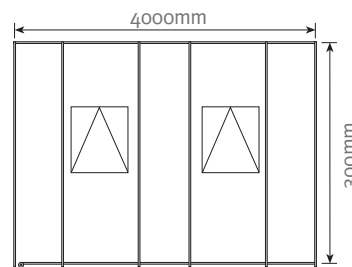



### Victorian

The Victorian roof can also work really well when you might not have as much space in the garden as you would like. The internal plaster finish on the roof can look really attractive with its facet front finish.

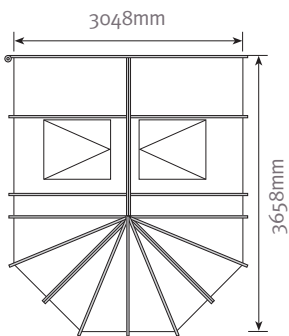

### Gable ended

The gable ended main feature is its continuous height it brings to the room owing to its long ridge down the centre. The gable also allows you to get the most from your roof windows giving you a light and airy space. Suitable for replacement or new build.

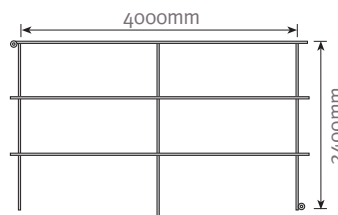

### Combination

Increase your options with a combination Guardian Sunroom. A P-Shape simply combines the benefits of two different styles to maximise your living environment. The combination can also come in what you call a T-shape.

As individual as you are.

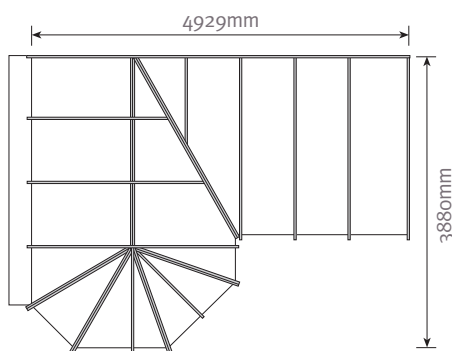

# Transform your living environment in twelve simple steps



Remove existing glass roof.  
Replace with Guardian warm  
roof ring beam.



Fix box gutter to existing wall



Fix ringbeam to existing windows

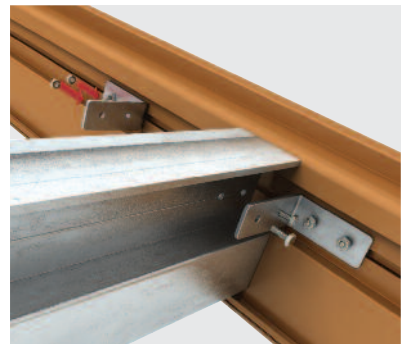

Fix rafters to ringbeam



Edwardian conservatory

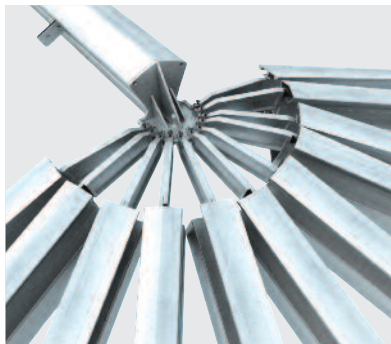

Victorian conservatory option

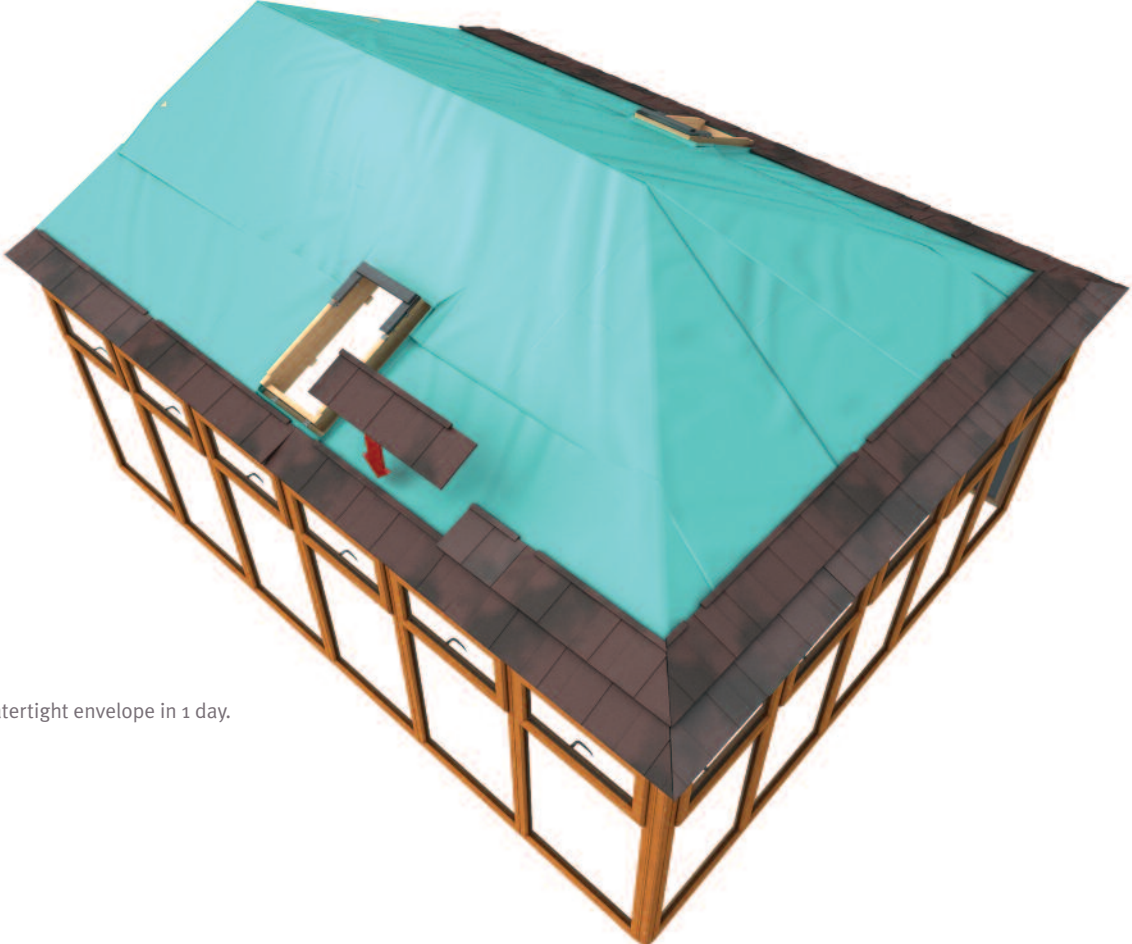

Watertight envelope in 1 day.

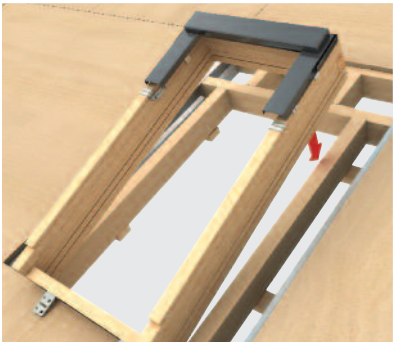

Install roof window frame

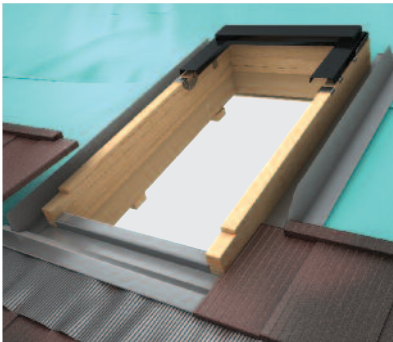

Install roof window

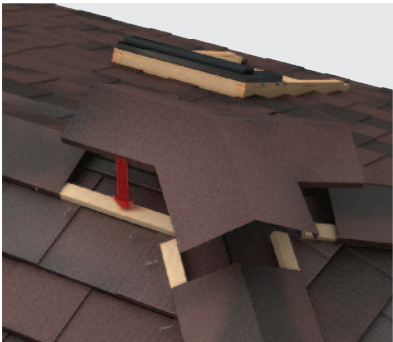

Fix rafter cap and ridge



Fit gutter



Plaster ceiling



# Gallery









# Gallery

Before



After









Celuplast Ltd.

Phone: 01 8167970 Fax: 01 8167988 Email: [ccr@celuplast.com](mailto:ccr@celuplast.com)